

SANY[®]

SPECIFICATION



120t



85.7m



95.2m* (*optional 选配)

STC1200T7

SANY TRUCK CRANE

QUALITY CHANGES THE WORLD

www.sanyglobal.com

V1.0

It is one of the core business units in SANY Group, specializing in the development and manufacturing of high-end wheel cranes, crawler cranes and tower cranes, including the complete range of wheel cranes from 8 to 2400t, crawler cranes from 25 to 4500t and tower cranes from 6 to 185t.

三一集团旗下核心事业部，从事高端轮式起重机、履带起重机、塔式起重机系列产品的研发制造。覆盖8-2400吨全吨位轮式起重机，25-4500吨全吨位履带起重机，6-185吨塔式起重机。



SANY CRANE



SANY TRUCK CRANE STC1200T7 / 120T LIFTING CAPACITY

Super load capacity

优越起重性能

Oval-shape large cross section boom 68.2m in full length, fixed jib 17.5m, leading in industry. Max. lifting moment of basic boom 3616.2kN·m, max. lifting moment of full extension boom 1834.6kN·m. Total counterweight 36.2t, equipped with automatic transmission and hydraulic retarder.

大截面卵型主臂,全伸臂长 68.2m,副臂长 17.5m,行业领先。基本臂最大起重力矩 3616.2kN·m,全伸臂最大起重力矩 1834.6kN·m。全配重 36.2t,配备自动挡变速器+液力缓速器。





Double pump intelligent flow distribution system

双泵智能流量分配系统

Well-known brand oil pump motor, the min. winch single rope speed can reach up to 1.7m/min, the min. stable slewing speed is less than 0.15°/s, easy to realize mm-level high precision operation. New shared double pump intelligent flow distribution system, independent luffing, confluence telescoping, combined motion stability increased by more than 50%. New operator's cab with joystick, provides smooth operation process.

知名品牌油泵马达, 卷扬单绳速度可达 1.7m/min, 回转最低稳定小于 0.15°/s, 轻松实现毫米级吊装。全新开发双泵智能流量分配系统, 变幅独立, 伸臂合流, 复合动作平稳性提升 50% 以上。全新操纵室, 手柄控制, 操作过程流畅。

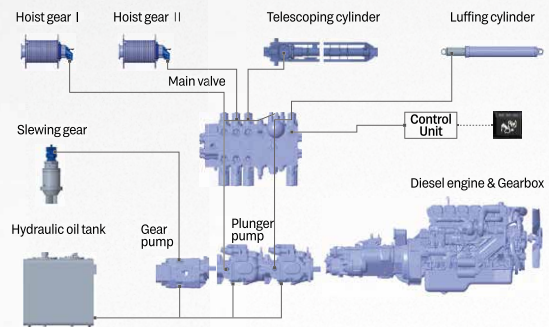

Strong heat dissipation ability

散热能力强

The heat dissipation area increases by 70% and the heat dissipation power increases by 60%. The system can run at high speed with full power for a long time without overheating, and the components are not easy to wear to ensure the service life of the whole system. The oil dispersing device is arranged on the side of the turntable to make the ventilation better.



散热面积增大 70%, 散热功率增加 60%, 系统长期全功率高速运行不过热, 元件不易老化, 确保整个系统使用寿命。油散布置在转台侧面, 通风条件好。

New Generation Cab Capacious, Convenient and Comfortable

搭载全新两室 操作便捷、宽敞舒适



Car Electronic Engineering, L2 drive assistance.
Full LCD instrument, equipped with anti-glare adjustment, able to weaken blue light effect.
Center control 12.1" multimedia entertainment screen, which can be connected with smart phone.
The seat with air suspension, automatic AC.

汽车级 EE 架构, L2 级辅助驾驶。
全液晶仪表, 夜光不同场景设计, 防眩目调校, 弱化蓝光伤害。
中控 12.1 寸多媒体娱乐屏, 手机互联。
气浮座椅, 空调自动控制。

iCab

i-Cab - Driver's cab

新两室 - 下车

Multi-function seat with air suspension, making driving more comfortable.

Double seats and foldable berth for the co-driver.

12.1-inch liquid crystal screen integrated with back-up image and multi-media.

Electric rearview mirror with electric heating, ensuring good field of view in foul weather.

Adjustable high-brightness LED headlamps/fog lamps, providing clear vision at night.

Reversing sensor with accurate distance detection capability, fully covering the parking area without blind spots, and effectively avoiding scratch and collision.

Full-automatic HVAC, able to automatically adjust indoor temperature as demanded.

主驾驶位配备气浮多功能座椅, 驾驶更舒适。

副驾驶位设置双座椅可折叠式卧铺。

12.1 寸液晶触摸大显示屏, 集成倒车影像、影音娱乐功能。

电动、电加热后视镜, 不惧怕恶劣冰雪天气。

高亮度可调节 LED 大灯 / 雾灯, 提供夜间清晰视野。

倒车雷达, 探头后方无死角, 精准探距, 防碰撞。

全自动冷暖空调, 自动根据需求调整室内温度。

SANY TRUCK CRANE STC1200T7 / 120T LIFTING CAPACITY

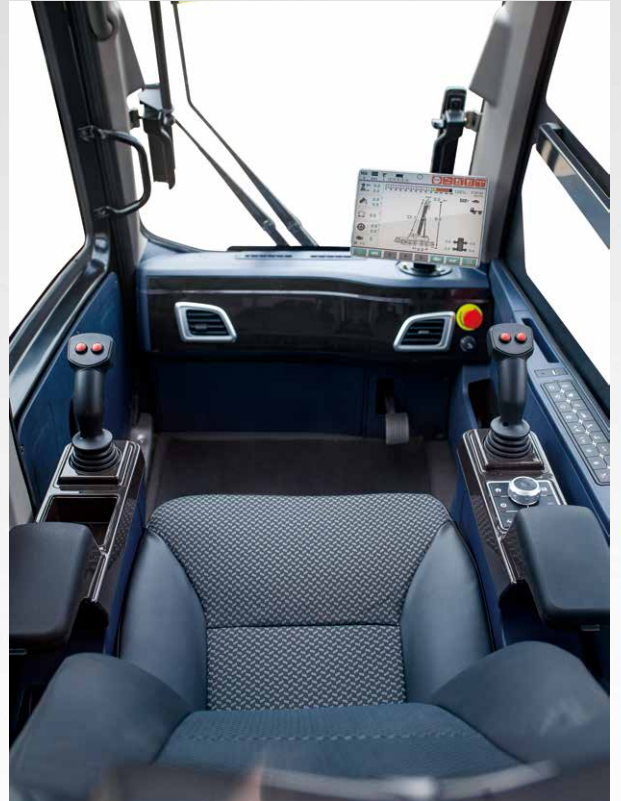

iCab

i-Cab - Operator's cab

新两室 - 上车

Seat widened by 450mm, and leg room increased by 30%.
Optional cab tiltable by 0-20°, relieving cervical fatigue during large-angle and long-boom operations.
Adjustable seat with maximum inclination of 140°, allowing the operator to lie flat and rest after work.
Electric seat linked with armrest box, enabling multi-dimensional adjustment for enhanced comfort.
45° tilted silicone button panel, easy to reach and operate.
Full-automatic HVAC, able to automatically adjust indoor temperature as demanded.

座椅、腿部活动空间较上一代增加 30%。
操纵室可实现 0-20° 上仰变位，大角度、长臂段作业可减缓颈椎疲劳。
可调式座椅，最大后仰 140°，操作手可以平躺休息。
电动座椅 + 扶手箱联动，多维度调节，更加舒适。
45° 斜置硅胶按键面板，触手可及，方便操控。
全自动冷暖空调，自动根据需求调整室内温度。

Overall Dimensions

整机尺寸

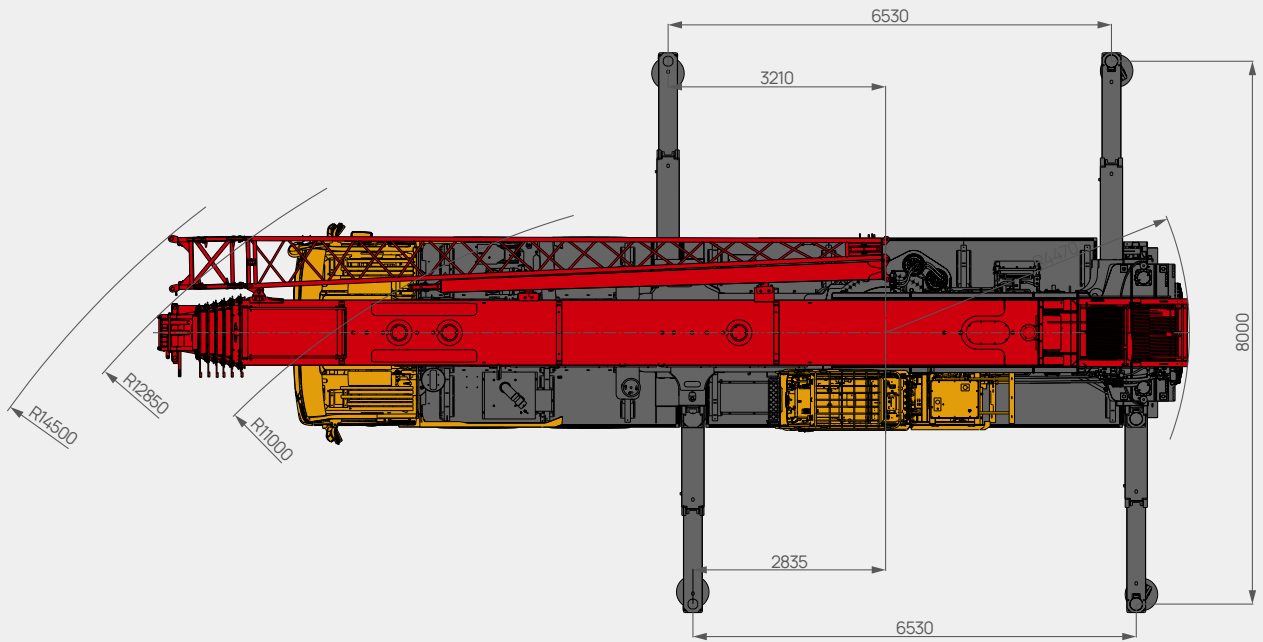
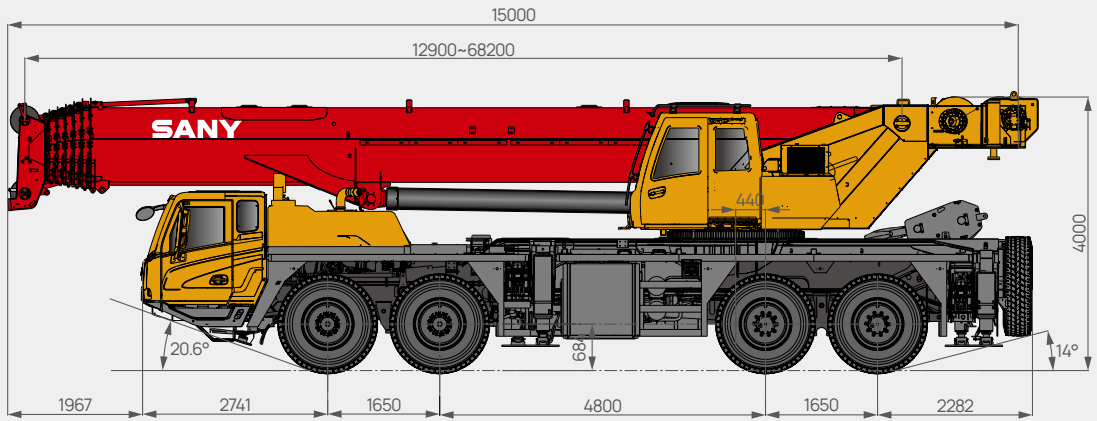

Technical Specification

整机参数

CATEGORY 类型	ITEM 项目	UNIT 单位	VALUE 参数	
CAPACITY 额定起重量	Max. lifting capacity 最大起重量	t	120	
WEIGHT 重量	Gross weight 整机总质量	t	48	
POWER (CHASSIS) 发动机参数 (下车)	Engine model 发动机型号 (排放标准)	-	ISLe375 30 (Euro III 欧 III)	
	Max. engine power 发动机最大功率	kW/rpm	275/2100	
	Max. engine torque 发动机最大输出扭矩	N·m/rpm	1550/1400	
DIMENSIONS 尺寸参数	Overall length 整机全长	mm	15000	
	Overall width 整机全宽	mm	2800	
	Overall height 整机全高	mm	4000	
TRAVEL 行驶参数	Max. travel speed 最高行驶速度	km/h	85	
	Steering radius 转弯半径	Min. steering radius 最小转弯半径	m	11.0
		Min. steering radius of boom tip 臂头最小转弯半径	m	14.5
	Wheel formula 车轮模式	-	8 × 4 × 8	
	Min. ground clearance 最小离地间隙	mm	357	
	Approach angle 接近角	°	20.6	
	Departure angle 离去角	°	14	
	Max. gradeability 最大爬坡度	-	40%	
	Fuel consumption per 100km 每 100 公里油耗	L	45	
	MAIN PERFORMANCE 主要性能参数	Working temperature range 使用温度区间	℃	-25~+45
Min. rated lifting radius 最小额定幅度		m	2.5	
Tail slewing radius 转台尾部回转半径		m	4.47	
Boom sections (Qty.) 臂节数		-	7	
Boom shape 臂形状		-	Oval shape 卵型	
Max. lifting moment 最大起重力矩		Basic boom 基本臂	kN·m	3616.2
		Full-extension boom 全伸主臂	kN·m	1834.6
		Full-extension boom + jib 全伸主臂 + 副臂	kN·m	968.2
		Full-extension boom + boom extension + jib 全伸主臂 + 延伸臂 + 副臂	kN·m	690
Boom length 臂长		Basic boom 基本臂	m	12.9
		Full-extension boom 全伸主臂	m	68.2
		Full-extension boom + jib 全伸主臂 + 副臂	m	85.7
		Full-extension boom + boom extension + jib 全伸主臂 + 延伸臂 + 副臂	m	95.2
Max. lifting height 最大起重高度		Basic boom 基本臂	m	13.4
		Full-extension boom 全伸主臂	m	68.7
		Full-extension boom + jib 全伸主臂 + 副臂	m	85.7
	Full-extension boom + boom extension + jib 全伸主臂 + 延伸臂 + 副臂	m	95.2	
Outrigger span (Longitudinal × Transverse) 支腿跨距 (纵 × 横)	m	8 × 6.53		
Jib offset 副臂安装角度	°	0, 15, 30		
AIRCONDITIONER 空调	In operator's cab 上车空调	-	Heating & Cooling 制冷、制热	
	In driver's cab 下车空调	-	Heating & Cooling 制冷、制热	

Technical Specification

整机参数



Axle Load 轴荷

Axle 轴	1	2	3	4	Gross weight 总重量
Axle load 轴荷 /t	12	12	11.9	11.9	47.8
Remark 备注	Traveling without jib, second winch, main hook and counterweight. 不带副臂/副卷扬/主钩/配重。				
Axle 轴	1	2	3	4	Gross weight 总重量
Axle load 轴荷 /t	15.6	15.6	19.3	19.3	69.8
Remark 备注	Traveling with jib, second winch, main hook, with counterweight=19.2t (rear 2.2t + rear 6t + front 5t + front 6t). 带副臂, 副卷扬, 主钩, 19.2t配重 (2.2t后配重+6t后配重+5t前配重+6t前配重)。				



Hook 吊钩

Rated load 额载 /t	Number of sheaves 滑轮数量	Rope rate 倍率	Hook weight/kg 吊钩重量
8.0 ●	0	1	210
75 (锚钩 Double eye hook) ●	5	10	735
90 ●	6	12	830

● Standard 标配 ○ Optional 选配



Operations 主要动作参数

Item 项目	Max.single rope lifting speed (empty load) 单绳速度 (空载)	Rope diameter/length 钢丝绳直径 / 长度	Max. single line pull 最大单绳拉力
Main winch 主卷扬	135 m/min	Φ20mm/275m	7.5t
Auxiliary winch 副卷扬	135 m/min	Φ20mm/200m	7.5t
Slewing speed 回转速度	1.7r/min		
Full luffing up/down time of boom 主臂起落幅时间	65s/90s		
Full extension/retraction time of boom 主臂伸缩时间	600s/680s		
Outrigger jack 垂直支腿	Extension 伸	25s	
	Retraction 缩	35s	
Outrigger beam 水平支腿	Extension 伸	35s	
	Retraction 缩	25s	

Counterweight Combinations

配重组合

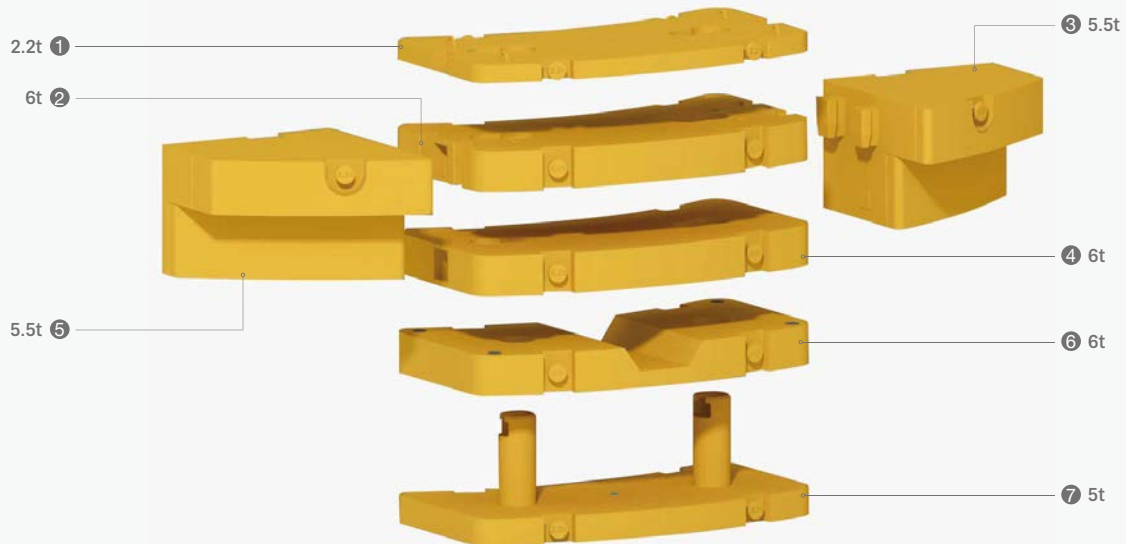

Total weight 总重量	①	②	③	④	⑤	⑥	⑦
	2.2t	6t	5.5t	6t	5.5t	6t	5t
0t							
2.2t	•						
7.2t	•						•
8.2t	•	•					
13.2t	•					•	•
19.2t	•	•				•	•
25.2t	•	•		•		•	•
36.2t	•	•	•	•	•	•	•

Transport Solution 运输方案

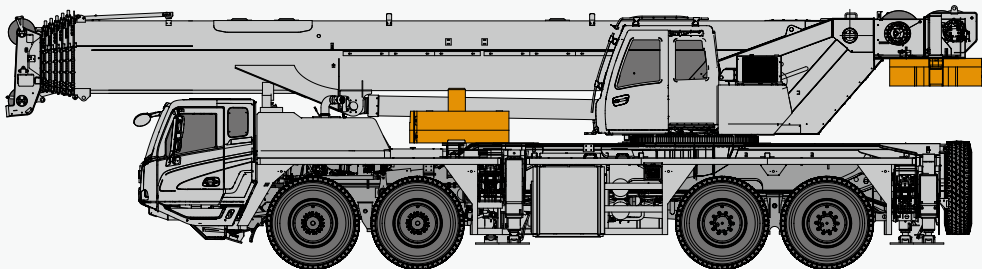

☐ 6t+6t+5t+2.2t=19.2t

Crane Introduction

整机介绍

Carrier 下车

Driver's cab 驾驶室

- Self-developed full width cab in ergonomic design, featuring vibration and external noise isolation.
- Equipped with pneumatic suspension seats with headrest, safety belt, adjustable steering wheel, large rear-view mirror, defroster, HVAC, stereo radio, and full set of instrument and controls, realizing safety and comfort.
- 自主开发全宽钢整体式钢结构驾驶室,采用人体工程学原理设计,减震性和封闭性优良。
- 配备气动悬置的驾驶座与副驾座、三点安全带、可调整式的转向盘、大视野后视镜、配有头枕的舒适驾驶椅、防雾扇、冷暖空调、立体收音机等,控制仪器和仪表齐全。
- 更加舒适、安全、人性化。

Carrier frame 车架

- Designed and manufactured by Sany, the box-type structure is expanded in height and length, with its rigidity increased by 30%, featuring increased bearing capacity.
- 三一设计、制造,采用矩形截面结构,车架加高加宽,相较槽型车架,刚性提升10%,承载能力得到大幅提升。

Chassis engine 底盘发动机

- Model: DF Cummins inline six-cylinder diesel engine with watercooler and inter cooler.
- Emission standard: Euro III.
- Fuel reservoir capacity: 450L.
- 型式:东康,直列六缸、水冷却、增压中冷、柴油发动机。
- 排放标准:欧三。
- 燃料箱有效容积:450L。

Transmission 变速箱

- FAST automatic transmission with synchronizer, suitable for long downhill working conditions.
- FAST自动挡变速箱,带液力缓速器,适合长下坡工况。

Transmission shaft 传动轴

- Optimized layout, higher torque output via contrate gear connecting transmission shaft cardan.
- 优化的传动轴布置,传动轴传动平稳、可靠。最优化力传输,采用端面齿联结传动轴,传递扭矩大。

Axle 车桥

- Axles 3, 4 are drive. All-wheel steering with built-in differential lock, realizing tougher ability to rough-terrain travelling. Two-stage reducer gear and more compact axle bags contribute to better accessibility. Press-welding axle housing technology, bearing capacity is stronger.
- 3、4轴为驱动轴,1、2、3、4轴为转向轴,驱动轴内置轴间和轮间差速器锁,使车辆有更强的脱困能力;双级减速,桥包体积更小,使车辆有更好的通过性;冲焊桥壳工艺,承载能力更强。

Suspension system 悬挂系统

- Front suspension is realized by independent leaf spring, and rear oscillation leaf spring. The leaf spring is verified by 100,000 cycling fatigue tests to ensure strength and ride comfort.
- 前轴采用独立式钢板弹簧,中后轴采用摆动支架式钢板弹簧平衡悬架系统;板簧经过超过10万次的疲劳试验,同时优化前后板簧的性能参数,保证强度的同时兼顾乘坐的舒适性。。

Steering 转向系统

- Machanical steering for axles 1 and 2, electro-hydraulic power steering for axles 3 and 4.
- 1、2桥机械式转向机构,3、4桥电液辅助转向。

Tires 轮胎

- Radial tires sized 445/95R25, commonly used for heavy-duty trucks.
- 子午线轮胎,445/95R25,广泛适用于重型汽车,通用性强。

Wheel formula 车轮模式

- 8 × 4 × 8.

Outrigger 支腿

- H-type layout, four point support with high strength steel plate, easy to operate, outrigger beam hydraulically telescoping, jack telescoping protected by two-way holding valve.
- H型支腿4点支撑,易操作、稳定性强;采用细晶粒高强度钢板材料,一、二级支腿全液压横向伸缩。垂直油缸采用双向液压锁进行安全保护。

Brake 制动系统

- The braking system includes service brake & parking brake & emergency brake & assisting brake & retarder brake (version with retarder).
- Service brake: air servo, dual circuit; front axle adopts drum brake, delivering stronger braking performance.
- Parking brake: functioning at axles 3 and 4 by spring-loaded air chamber.
- Emergency brake: performed by accumulator releasing pressure.
- Assisting brake: engine exhaust brake, safety assured when driving down long slopes.
- 制动系统包括行车制动、驻车制动、应急制动和辅助制动、缓速器制动。
- 行车制动采用双回路制动系统,所有车轮均用空气伺服制动器,前桥采用模式制动器+双气室,制动能力更强。
- 驻车制动是通过气室内弹簧作用在第三、四桥上。
- 应急制动由蓄能器储能断气制动兼做应急制动。
- 辅助制动为排气制动,保证在下长坡时的制动安全,保证行车的安全可靠。

Electrical system 电气系统

- 2*12V maintenance-free battery with a mechanical power switch, the overall power can be cut off manually. CAN instrument, data integration between superstructure and chassis.
- 2 × 12V 免维护蓄电池,配有机械式电源总开关,可手动切断整车电源;总线控制系统,可实现上下车信息交互。

Crane Introduction

整机介绍

Operator's cab 操纵室

- It adopts pressed and welded construction, equipped with safety glass, sun shade, outward opening door, joystick mounted on the control box in line with the principle of man-machine engineering. Corrosion-resistant FRP reinforced structure, fully covered softened interior, panoramic skylight, operator seat back tiltable and other use-friendly design, making it comfortable and easy to operate. Touch screen of adjustable angle realizes multi-screen & multi-angle monitoring to ensure working safety and the one-click operation. The main control console is combined with the operation display system for convenient man-machine interaction. Cab 20° tiltable, designed for easy observation of load at heights. Cooling & heating A/C available.
- 采用冲压成型的全焊接结构, 装有安全玻璃, 车窗装有遮阳帘, 外开式车门, 操纵杆安装在操纵箱上, 符合人机工程原理; 防腐玻璃钢强化复合结构、全覆盖软化内饰、全景式天窗、操作手座椅靠背可倾斜定位等人性化设计, 操作舒适、轻松; 触摸式显示屏, 视角可调节、多画面、多角度监控保证作业安全, 满足一键式操作; 主控台与操作显示系统有机结合, 人机交互方便快捷; 操纵室可向上倾斜20°, 满足高处的作业观察需要; 配备冷暖空调。

Boom & telescoping system 伸缩系统

- Seven sections of oval shape cross section welded by high strength structural steel. Telescoping is realized by single cylinder pin.
- 68.2m full-extension boom, 17.5m jib, optional 9.5m boom extension. Max. lifting height of boom + jib 85.7m.
- 七节臂, 全伸臂长68.2m, 副臂17.5m, 可选配9.5m延伸臂, 带副臂最大起升高度85.7m。由高强度焊接结构钢制成, 卵形截面, 单缸插销。

Hoist 起升机构

- Efficient and energy saving speed regulation is realized by double variables of pump and motor. Winch balance valve coupled with exclusive anti-slip tech contribute to smoother hoisting.
- Normally closed type winch brake and winch balance valve are set to prevent hook falling and stalling.
- Standard 8.0t & 90t hook and 75t double eye hook.
- The main winch adopts electric proportional variable motor, offering precise control and smooth operation with stepless speed adjustment.
- 275m main winch wire rope with 20mm diameter, 200m aux. winch wire rope with 20mm diameter.
- 泵、马达双变量调速, 高效节能。卷扬平衡阀与独特的防溜钩技术完美结合, 重物起落平稳。
- 常闭式卷扬制动器, 并设置卷扬平衡阀, 可防止落钩失速。
- 标配8.0t、90t吊钩、75t锚钩。
- 主卷扬采用电比例变量马达, 卷扬微动性、平稳性好, 能实现无级变速。主、副卷扬钢丝绳直径均为20mm, 长度分别为275m, 200m。

Luffing system 变幅系统

- Passive luffing down with balance system, reducing energy cost yet raising stability. Adopting single cylinder and front hinge, it saves more effort in luffing and improves the situation of load of boom, and also uses electric proportional control balance valve. Luffing angle: -1.5°~80°.
- 自重落幅, 更加节能。采用单根油缸, 前铰支布置, 变幅更省力且起重臂受力得到改善; 采用电比例控制平衡阀。变幅角度: -1.5°~80°。

Slewing 回转系统

- Integrated slewing buffer valve with free swing function. Smooth slewing start & control with excellent inching performance.
- 带集成回转缓冲阀, 具有自由滑转功能, 回转启动和控制平稳, 微动性卓越。

Hydraulics 液压系统

- The all new smart double pump flow system lifts maneuverability of combined motions by 50%. The boom can luff at shunting mode and telescope at confluence mode.
- Load sensing variable piston pump can control flow in high precision, reducing energy loss significantly.
- Electrically controlled valve functions flow compensation and load sensing control, securing stable control over single and combined motions.
- Electronically controlled variable motor for winch is of highly efficiency, stability and low noise.
- 采用全新开发双泵智能流量系统, 变幅独立, 伸臂合流, 复合动作操控性提升50%以上。
- 采用进口负载敏感变量柱塞泵, 能实时调节油泵排量, 实现高精度的流量控制, 极大的降低能量损耗。
- 电控主阀具备流量补偿、负载反馈控制功能, 能在各种工况下, 轻松实现单个动作和组合动作的稳定控制。
- 卷扬采用电控变量马达, 高速效率高, 低速稳定噪音小; 主副卷扬单绳最大速度达135m/min。

Crane Introduction

整机介绍

Superstructure 上车



Control system 控制系统

- Vehicle data display system: equipped with multiple sensors to give timely feedback of data information, achieving real-time monitoring of the vehicle working state.
- Man-machine interaction interface: more user-friendly interface with rich and clear information. Customers can set the vehicle controllability according to their personal operation habits and different operating conditions to fully meet the preferred needs of customers.
- 整车数据显示系统: 配置丰富的传感器件, 及时反馈数据信息, 实现实时监控, 确保随时掌控整车工作状态。
- 人机交互界面: 人机交互界面设计人性化, 信息丰富而清晰, 客户可根据个人操作习惯和不同使用条件自行设置整车操控性, 充分满足客户的个性化需求。



Counterweight 配重

- Movable counterweight 8 combinations: 0t, 2.2t, 7.2t, 8.2t, 13.2t, 19.2t, 25.2t, 36.2t. Satisfying various demands and giving full play to the structural advantage, CW assembly and disassembly controlled by remote device.
- 组合式可变平衡重。0/2.2/7.2/8.2/13.2/19.2/25.2/36.2共8种组合方式, 详见附件组合表, 可满足不同工况的需求, 最大限度发挥结构件性能, 可遥控拆卸及安装, 微动性好。



Safety equipment 安全装置

- Load moment indicator: A method of analytical mechanics is adopted and a moment limiter calculation system based on the hoisting mechanics model is established. Through online empty-load calibration, the rated hoisting accuracy can reach $\pm 3\%$ to fully protect the hoisting operation.
- The hydraulic system is equipped with balance valve, relief valve, two-way holding valve, etc. to realize stability and reliability.
- Boom head and jib head are equipped with A2B switch to prevent the wire rope from over winding.
- The boom head is equipped with anemometer to detect whether the wind speed at heights exceeds the allowable range.
- The length & angle sensor and pressure sensor are equipped to display the operating status of the crane in real time, automatically cut off dangerous actions, and give a buzzer alarm.
- 采用分析力学方法, 建立了基于吊重力学模型的力矩限制器计算系统, 通过在线空载标定, 吊重精度达到 $\pm 3\%$ 。
- 液压系统配置液压平衡阀、溢流阀、双向液压锁等元件, 实现液压系统稳定可靠。
- 主、副臂臂端配置高度限位器, 防止钢丝绳过卷。
- 臂端装有风速仪, 检测高空风速是否超过可作业允许范围。
- 配置长度角度传感器、压力传感器, 实时显示起重机作业状态, 自动切断危险动作, 蜂鸣报警。



Optional equipment at extra fees 选配

- 75t & 100t hook, 9.5m boom extension, outrigger pads.
- Special painting.
- Other equipment available upon request.
- 75t、100t吊钩, 9.5m延长臂, 支腿垫板。
- 特殊涂装。
- 其他配置视需求定。

Operating Range - Telescopic Boom (T)

起升高度曲线 - 主臂

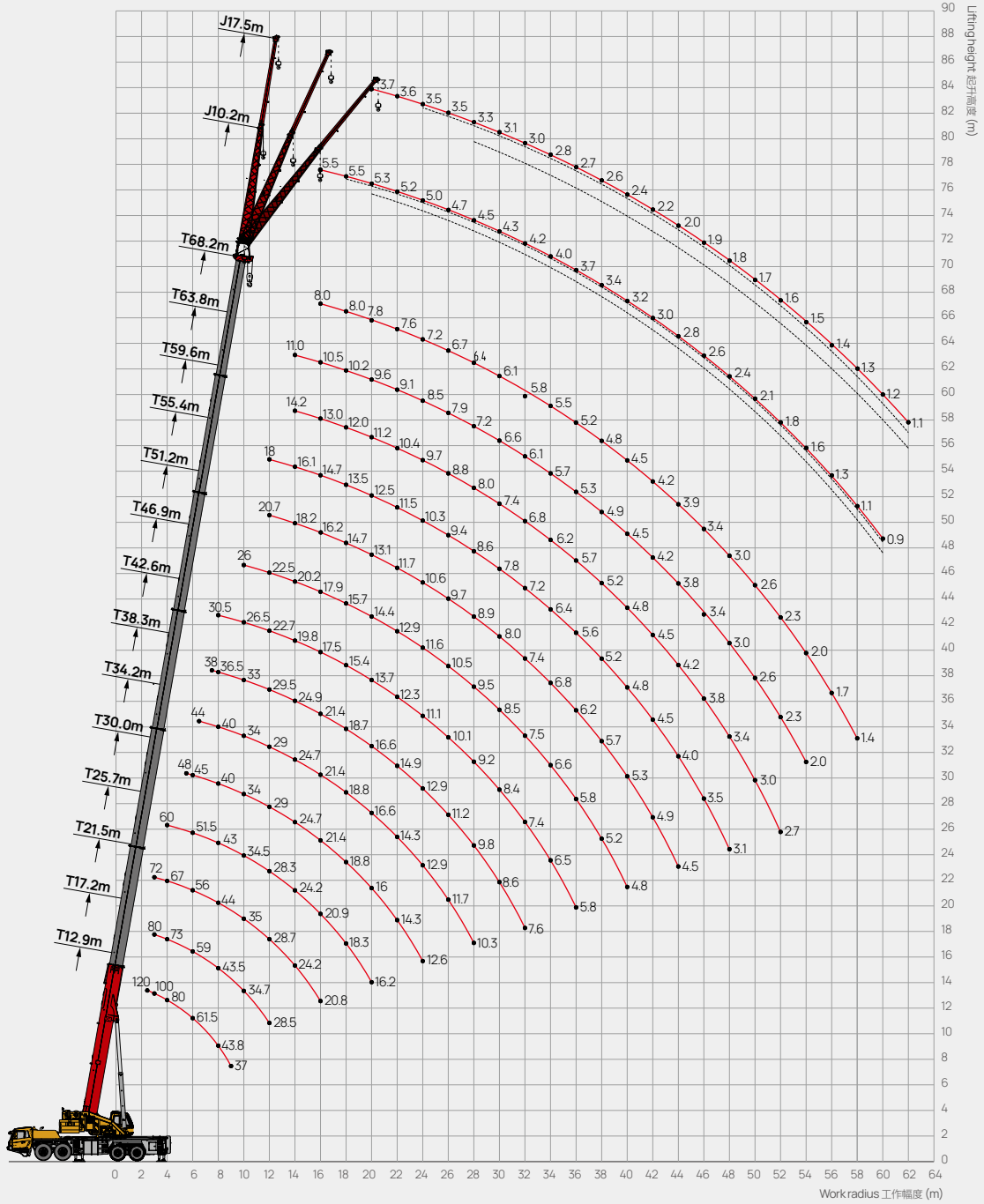



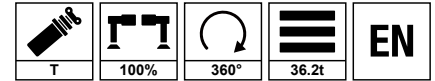

Load Chart - Telescopic Boom (T)

性能表 - 主臂



Unit: t

	12.9	17.2	21.5	25.7	30.0	34.2	38.4	42.6	46.9	51.2	55.4	59.6	63.8	68.2	
2.5	120*														2.5
3.0	100.0	80.0	72.0												3.0
3.5	87.0	75.0	68.0												3.5
4.0	80.0	73.0	67.0	60.0											4.0
4.5	74.5	71.0	67.0	58.0											4.5
5.0	69.0	67.0	65.0	56.0											5.0
5.5	65.0	63.0	60.0	54.0	48.0										5.5
6.0	61.5	59.0	56.0	51.5	45.0										6.0
6.5	56.0	54.0	53.0	49.0	43.0	44.0									6.5
7.0	50.5	49.5	50.0	47.0	42.0	42.5									7.0
7.5	46.8	46.0	46.3	45.0	41.0	41.0	37.5								7.5
8.0	43.8	43.5	44.0	43.0	40.0	40.0	36.5	30.5							8.0
9.0	37.0	39.0	39.5	39.0	37.0	37.0	34.5	28.5							9.0
10.0		34.7	35.0	34.5	34.0	34.0	33.0	26.5	26.0						10.0
12.0		28.5	28.7	28.3	29.0	29.0	29.5	22.7	22.5	20.7	18.0				12.0
14.0			24.2	24.2	24.7	24.7	24.9	19.8	20.2	18.2	16.1	14.2	11.0		14.0
16.0			20.8	20.9	21.4	21.4	21.4	17.5	17.9	16.2	14.7	13.0	10.5	8.0	16.0
18.0				18.3	18.8	18.8	18.7	15.4	15.7	14.7	13.5	12.0	10.2	8.0	18.0
20.0				16.2	16.0	16.6	16.6	13.7	14.4	13.1	12.5	11.2	9.6	7.8	20.0
22.0					14.3	14.3	14.9	12.3	12.9	11.7	11.5	10.4	9.1	7.6	22.0
24.0					12.6	12.9	12.9	11.1	11.6	10.6	10.3	9.7	8.5	7.2	24.0
26.0						11.7	11.2	10.1	10.5	9.7	9.4	8.8	7.9	6.7	26.0
28.0						10.3	9.8	9.2	9.5	8.9	8.6	8.0	7.2	6.4	28.0
30.0							8.6	8.4	8.5	8.0	7.8	7.4	6.6	6.1	30.0
32.0							7.6	7.4	7.5	7.4	7.2	6.8	6.1	5.8	32.0
34.0								6.5	6.6	6.8	6.4	6.2	5.7	5.5	34.0
36.0								5.8	5.8	6.2	5.6	5.7	5.3	5.2	36.0
38.0									5.2	5.7	5.2	5.2	4.9	4.8	38.0
40.0									4.8	5.3	4.8	4.8	4.5	4.5	40.0
42.0										4.9	4.5	4.5	4.2	4.2	42.0
44.0										4.5	4.0	4.2	3.8	3.9	44.0
46.0											3.5	3.8	3.4	3.4	46.0
48.0											3.1	3.4	3.0	3.0	48.0
50.0												3.0	2.6	2.6	50.0
52.0												2.7	2.3	2.3	52.0
54.0													2.0	2.0	54.0
56.0														1.7	56.0
58.0														1.4	58.0
	16	12	10	8	7	6	5	5	4	3	3	2	2	2	



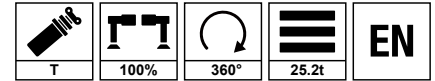

Remark: * Need additional device.
备注: * 代表需要借助辅助装置。

Load Chart - Telescopic Boom (T)

性能表 - 主臂



Unit: t

	12.9	17.2	21.5	25.7	30.0	34.2	38.4	42.6	46.9	51.2	55.4	59.6	63.8	68.2	
2.5	120*														2.5
3.0	100.0	80.0	68.0												3.0
3.5	80.0	75.0	68.0												3.5
4.0	76.0	73.0	67.0	60.0											4.0
4.5	72.0	71.0	67.0	58.0											4.5
5.0	68.0	67.0	65.0	56.0											5.0
5.5	63.5	63.0	60.0	54.0	48.0										5.5
6.0	61.0	59.0	56.0	51.5	45.0										6.0
6.5	55.0	54.0	53.0	49.0	43.0	44.0									6.5
7.0	50.0	49.5	50.0	47.0	42.0	42.5									7.0
7.5	46.5	46.0	46.3	45.0	41.0	41.0	37.5								7.5
8.0	43.0	43.5	44.0	43.0	40.0	40.0	36.5	30.5							8.0
9.0	37.0	39.0	39.5	39.0	37.0	37.0	34.5	28.5							9.0
10.0		34.7	35.0	34.5	34.0	34.0	33.0	26.5	26.0						10.0
12.0		28.5	28.7	28.3	29.0	29.0	29.5	22.7	22.5	20.7	18.0				12.0
14.0			23.8	24.2	23.6	24.0	24.8	19.8	20.2	18.2	16.1	14.2	11.0		14.0
16.0			18.9	19.8	19.8	20.4	19.8	17.5	17.9	16.2	14.7	13.0	10.5	8.0	16.0
18.0				16.3	17.1	16.8	16.2	15.4	15.5	14.7	13.5	12.0	10.2	8.0	18.0
20.0				13.6	14.4	14.1	13.5	13.4	13.4	13.0	12.5	11.2	9.6	7.8	20.0
22.0					12.2	11.9	11.4	11.3	11.3	11.5	11.1	10.4	9.1	7.6	22.0
24.0					10.5	10.2	10.0	9.5	9.6	10.1	9.4	9.7	8.5	7.2	24.0
26.0						8.8	9.2	8.1	8.5	9.3	8.1	8.3	7.9	6.7	26.0
28.0						7.6	8.1	7.0	7.8	8.2	7.6	7.7	7.2	6.4	28.0
30.0							7.1	6.3	7.2	7.1	6.6	6.9	6.5	6.1	30.0
32.0								6.3	5.6	6.6	6.3	5.7	6.0	5.6	32.0
34.0									5.2	6.0	5.5	5.1	5.3	4.8	34.0
36.0									4.6	5.3	4.9	4.7	4.6	4.2	36.0
38.0										4.7	4.3	4.3	4.0	3.6	38.0
40.0										4.2	3.8	3.8	3.5	3.1	40.0
42.0											3.5	3.3	3.0	2.6	42.0
44.0												3.2	2.9	2.6	44.0
46.0													2.5	2.2	46.0
48.0														2.2	48.0
50.0														1.6	50.0
52.0														1.3	52.0
54.0														0.9	54.0
56.0															56.0
58.0															58.0
	16	12	10	8	7	6	5	5	4	3	3	2	2	2	



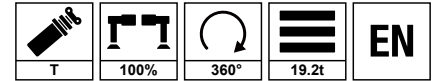

Remark: * Need additional device.
备注: * 代表需要借助辅助装置。

Load Chart - Telescopic Boom (T)

性能表 - 主臂



Unit: t

	12.9	17.2	21.5	25.7	30.0	34.2	38.4	42.6	46.9	51.2	55.4	59.6	63.8	68.2	
2.5	120*														2.5
3.0	100.0	80.0	68.0												3.0
3.5	80.0	75.0	68.0												3.5
4.0	76.0	73.0	67.0	60.0											4.0
4.5	72.0	71.0	67.0	58.0											4.5
5.0	68.0	67.0	65.0	56.0											5.0
5.5	63.5	63.0	60.0	54.0	48.0										5.5
6.0	58.0	57.5	56.0	51.5	45.0										6.0
6.5	53.0	52.5	52.5	49.0	43.0	44.0									6.5
7.0	49.0	49.0	49.0	47.0	42.0	42.5									7.0
7.5	45.0	45.5	46.0	45.0	41.0	41.0	37.5								7.5
8.0	42.0	43.0	43.0	43.0	40.0	40.0	36.5	30.5							8.0
9.0	36.5	38.0	38.0	37.0	37.0	37.0	34.5	28.5							9.0
10.0		34.0	34.0	33.0	33.5	34.0	33.0	26.5	26.0						10.0
12.0		26.4	26.9	27.9	27.2	28.2	28.0	22.7	22.5	20.7	18.0				12.0
14.0			20.5	21.5	22.4	22.1	21.5	19.8	20.2	18.2	16.1	14.2	11.0		14.0
16.0			16.1	17.1	17.9	17.6	17.1	16.9	16.5	16.2	14.7	13.0	10.5	8.0	16.0
18.0				14.7	14.7	14.4	14.3	13.7	13.8	14.0	13.5	12.0	10.2	8.0	18.0
20.0				12.3	12.3	12.0	12.5	11.3	11.3	11.6	11.1	11.2	9.6	7.8	20.0
22.0					10.4	10.0	10.6	9.4	10.0	10.6	9.3	9.5	9.1	7.6	22.0
24.0						8.8	9.0	9.0	8.1	9.3	9.0	8.4	8.6	8.3	24.0
26.0							8.1	7.7	7.3	8.2	7.7	7.1	7.5	7.0	26.0
28.0							7.0	6.6	6.3	7.1	6.7	6.1	6.4	6.0	28.0
30.0								5.7	5.4	6.2	5.8	5.8	5.5	5.0	30.0
32.0								5.0	4.8	5.4	5.3	5.0	4.7	4.3	32.0
34.0									4.4	4.7	4.7	4.3	4.0	3.6	34.0
36.0									4.1	4.1	4.1	3.7	3.4	3.0	36.0
38.0										3.6	3.6	3.2	2.9	2.5	38.0
40.0										3.2	3.1	2.7	2.5	2.0	40.0
42.0											2.7	2.3	2.1	1.6	42.0
44.0											2.3	2.0	1.7	1.3	44.0
46.0												1.6	1.4	0.9	46.0
48.0												1.3	1.1		48.0
50.0													0.8		50.0
52.0															52.0
54.0															54.0
56.0															56.0
58.0															58.0
	16	12	10	8	7	6	5	5	4	3	3	2	2	2	



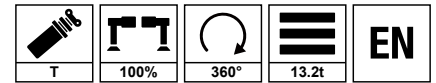

Remark: * Need additional device.
备注: * 代表需要借助辅助装置。

Load Chart - Telescopic Boom (T)

性能表 - 主臂



Unit: t

	12.9	17.2	21.5	25.7	30.0	34.2	38.4	42.6	46.9	51.2	55.4	59.6	63.8	68.2	
2.5	120*														2.5
3.0	100.0	80.0	68.0												3.0
3.5	80.0	75.0	68.0												3.5
4.0	76.0	73.0	67.0	60.0											4.0
4.5	72.0	71.0	67.0	58.0											4.5
5.0	67.0	67.0	65.0	56.0											5.0
5.5	61.0	61.0	60.0	54.0	48.0										5.5
6.0	55.0	55.0	55.0	51.5	45.0										6.0
6.5	50.5	50.5	50.0	49.0	43.0	44.0									6.5
7.0	46.0	47.0	47.5	46.0	42.0	42.5									7.0
7.5	42.0	43.0	43.5	42.0	41.0	41.0	37.5								7.5
8.0	38.5	39.7	40.0	40.0	38.5	38.5	36.5	30.5							8.0
9.0	33.0	34.3	34.5	34.5	34.0	33.0	32.0	28.5							9.0
10.0		30.0	30.0	30.0	29.5	28.5	28.0	26.5	26.0						10.0
12.0		22.3	22.8	23.9	24.9	24.5	23.9	22.7	22.5	20.7	18.0				12.0
14.0			17.2	19.0	19.1	18.8	18.2	18.0	18.1	17.9	16.1	14.2	11.0		14.0
16.0			13.2	15.2	15.2	14.8	15.4	14.1	14.1	14.4	13.9	13.0	10.5	8.0	16.0
18.0				12.2	12.2	12.3	12.5	11.5	11.8	12.5	11.0	11.4	10.2	8.0	18.0
20.0				10.1	10.0	10.6	10.2	9.3	10.8	10.3	9.7	9.9	9.6	7.8	20.0
22.0					9.0	8.9	8.5	8.2	9.0	8.7	7.9	8.3	7.8	7.6	22.0
24.0					7.7	7.5	7.1	7.1	7.6	7.6	6.9	6.9	6.5	6.5	24.0
26.0						6.4	6.0	6.4	6.5	6.5	6.1	5.8	5.3	5.4	26.0
28.0						5.5	5.1	5.8	5.5	5.5	5.1	4.9	4.4	4.4	28.0
30.0							4.3	5.1	4.8	4.7	4.3	4.1	3.6	3.6	30.0
32.0							3.6	4.4	4.1	4.0	3.7	3.4	2.9	3.0	32.0
34.0								3.8	3.5	3.4	3.1	2.8	2.4	2.4	34.0
36.0								3.3	3.0	2.9	2.5	2.3	1.8	1.9	36.0
38.0									2.5	2.5	2.1	1.8	1.4	1.4	38.0
40.0									2.1	2.1	1.7	1.4	1.0	1.0	40.0
42.0										1.7	1.3	1.1			42.0
44.0										1.4	1.0	0.8			44.0
46.0															46.0
48.0															48.0
50.0															50.0
52.0															52.0
54.0															54.0
56.0															56.0
58.0															58.0
	16	12	10	8	7	6	5	5	4	3	3	2	2	2	





Remark: * Need additional device.
备注: * 代表需要借助辅助装置。

Load Chart - Telescopic Boom (T)

性能表 - 主臂



Unit: t

	12.9	17.2	21.5	25.7	30.0	34.2	38.4	42.6	46.9	51.2	55.4	59.6	63.8	68.2	
2.5	120*														2.5
3.0	100.0	76.0	68.0												3.0
3.5	80.0	75.0	68.0												3.5
4.0	76.0	73.0	67.0	60.0											4.0
4.5	71.0	71.0	67.0	58.0											4.5
5.0	64.5	64.5	63.5	56.0											5.0
5.5	58.0	58.5	57.0	54.0	48.0										5.5
6.0	53.0	53.5	52.0	51.5	45.0										6.0
6.5	48.5	49.0	47.8	46.5	43.0	44.0									6.5
7.0	44.7	45.2	43.8	43.6	42.0	42.5									7.0
7.5	41.0	41.5	40.6	40.5	39.5	39.5	37.5								7.5
8.0	37.5	38.0	37.1	37.0	36.5	36.0	34.5	30.5							8.0
9.0	31.5	32.0	31.2	31.0	30.5	30.0	28.5	28.5							9.0
10.0		26.9	27.5	28.7	29.5	28.5	28.0	26.5	26.0						10.0
12.0		18.9	19.4	21.5	21.5	21.1	20.6	20.3	20.4	20.2	18.0				12.0
14.0			15.5	16.2	16.2	15.8	16.5	15.1	15.1	15.7	14.9	14.2	11.0		14.0
16.0			12.2	12.6	12.6	13.3	12.8	11.9	13.1	12.9	12.2	11.7	10.5	8.0	16.0
18.0				10.0	10.6	10.7	10.2	9.9	10.8	10.3	9.6	10.0	9.5	8.0	18.0
20.0				8.1	8.8	8.7	8.3	8.2	8.8	8.8	8.0	8.1	7.6	7.6	20.0
22.0					7.3	7.2	6.8	7.6	7.3	7.3	6.9	6.6	6.1	6.1	22.0
24.0					6.1	6.0	5.6	6.4	6.1	6.0	5.7	5.4	4.9	4.9	24.0
26.0						5.0	4.6	5.4	5.1	5.0	4.7	4.4	3.9	4.0	26.0
28.0						4.2	3.8	4.6	4.3	4.2	3.8	3.6	3.1	3.1	28.0
30.0							3.1	3.9	3.6	3.5	3.1	2.9	2.4	2.4	30.0
32.0								2.5	3.3	3.0	2.9	2.5	2.3	1.8	32.0
34.0									2.8	2.5	2.4	2.0	1.8	1.3	34.0
36.0									2.3	2.0	1.9	1.6	1.3	0.9	36.0
38.0										1.6	1.5	1.2	0.9		38.0
40.0										1.3	1.2	0.8			40.0
42.0											0.9				42.0
44.0															44.0
46.0															46.0
48.0															48.0
50.0															50.0
52.0															52.0
54.0															54.0
56.0															56.0
58.0															58.0
	16	12	10	8	7	6	5	5	4	3	3	2	2	2	



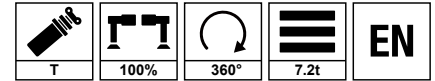

Remark: * Need additional device.
备注: * 代表需要借助辅助装置。

Load Chart - Telescopic Boom (T)

性能表 - 主臂



Unit: t

	12.9	17.2	21.5	25.7	30.0	34.2	38.4	42.6	46.9	51.2	55.4	59.6	63.8	68.2	
2.5	120*														2.5
3.0	100.0	76.0	68.0												3.0
3.5	80.0	75.0	68.0												3.5
4.0	76.0	73.0	67.0	60.0											4.0
4.5	71.0	71.0	67.0	58.0											4.5
5.0	64.0	64.0	63.5	56.0											5.0
5.5	57.5	58.0	57.0	54.0	48.0										5.5
6.0	52.5	53.0	52.0	51.5	45.0										6.0
6.5	48.0	48.5	47.8	46.5	43.0	44.0									6.5
7.0	44.2	44.7	43.8	43.6	42.0	42.5									7.0
7.5	40.5	41.0	40.6	40.0	39.5	39.5	37.5								7.5
8.0	37.0	37.5	37.0	36.5	36.5	36.0	34.5	30.5							8.0
9.0	30.9	31.5	31.0	30.5	30.5	30.0	28.5	28.5							9.0
10.0		26.0	26.6	27.8	28.9	28.5	27.8	26.5	26.0						10.0
12.0		18.1	18.6	20.8	20.8	20.4	20.6	19.6	19.7	20.1	18.0				12.0
14.0			15.1	15.6	15.6	15.3	15.9	14.4	14.7	15.7	14.3	14.2	11.0		14.0
16.0			11.7	12.1	12.0	12.7	12.4	11.3	12.9	12.4	11.7	11.6	10.5	8.0	16.0
18.0				9.6	10.3	10.2	9.9	9.5	10.3	10.3	9.2	9.6	9.1	8.0	18.0
20.0				7.7	8.4	8.3	8.0	8.2	8.4	8.4	8.0	7.7	7.2	7.3	20.0
22.0					7.0	6.8	6.5	7.3	7.0	6.9	6.5	6.2	5.8	5.8	22.0
24.0					5.8	5.7	5.3	6.1	5.8	5.7	5.4	5.1	4.6	4.6	24.0
26.0						4.7	4.4	5.1	4.8	4.8	4.4	4.1	3.6	3.7	26.0
28.0						3.9	3.6	4.3	4.0	4.0	3.6	3.3	2.9	2.9	28.0
30.0							2.9	3.7	3.3	3.3	2.9	2.6	2.2	2.2	30.0
32.0								2.4	3.1	2.7	2.7	2.3	2.1	1.6	32.0
34.0									2.6	2.2	2.2	1.8	1.6	1.1	34.0
36.0									2.1	1.8	1.8	1.4	1.1		36.0
38.0										1.4	1.4	1.0			38.0
40.0											1.1	1.0			40.0
42.0															42.0
44.0															44.0
46.0															46.0
48.0															48.0
50.0															50.0
52.0															52.0
54.0															54.0
56.0															56.0
58.0															58.0
	16	12	10	8	7	6	5	5	4	3	3	2	2	2	



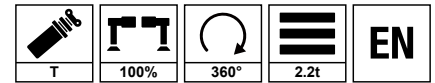

Remark: * Need additional device.
备注: * 代表需要借助辅助装置。

Load Chart - Telescopic Boom (T)

性能表 - 主臂



Unit: t

	12.9	17.2	21.5	25.7	30.0	34.2	38.4	42.6	46.9	51.2	55.4	59.6	63.8	68.2	
2.5	120*														2.5
3.0	100.0	76.0	68.0												3.0
3.5	80.0	75.0	68.0												3.5
4.0	75.0	73.0	67.0	60.0											4.0
4.5	68.5	68.0	67.0	58.0											4.5
5.0	61.5	61.5	60.5	56.0											5.0
5.5	55.5	55.5	54.5	54.0	48.0										5.5
6.0	50.0	50.0	49.5	48.0	45.0										6.0
6.5	45.5	45.5	45.0	44.5	43.0	44.0									6.5
7.0	41.0	41.0	40.5	40.0	40.0	39.0									7.0
7.5	37.0	37.0	36.5	36.0	35.5	35.0	35.0								7.5
8.0	33.1	34.4	35.1	34.9	34.2	32.0	34.5	30.5							8.0
9.0	25.7	26.8	27.4	28.7	28.3	28.0	28.5	28.5							9.0
10.0		21.4	22.0	24.5	24.5	24.1	24.3	23.1	23.2						10.0
12.0		15.2	16.5	17.0	17.0	17.5	17.4	16.2	16.9	17.4	15.8				12.0
14.0			12.0	12.5	12.9	13.2	12.8	12.4	13.4	12.8	12.1	12.5	11.0		14.0
16.0			9.1	9.5	10.3	10.2	9.8	9.8	10.3	10.3	9.6	9.5	9.0	8.0	16.0
18.0				7.9	8.1	8.0	7.6	8.5	8.1	8.1	7.7	7.4	6.9	6.9	18.0
20.0				6.3	6.5	6.4	6.0	6.9	6.5	6.5	6.1	5.8	5.3	5.3	20.0
22.0					5.2	5.1	4.8	5.6	5.2	5.2	4.8	4.5	4.0	4.1	22.0
24.0					4.3	4.1	3.8	4.6	4.2	4.2	3.8	3.5	3.1	3.1	24.0
26.0						3.3	3.0	3.7	3.4	3.4	3.0	2.7	2.2	2.3	26.0
28.0						2.6	2.3	3.0	2.7	2.7	2.3	2.0	1.6	1.6	28.0
30.0							1.7	2.5	2.1	2.1	1.7	1.4	1.0	1.0	30.0
32.0							1.3	2.0	1.6	1.6	1.2	0.9			32.0
34.0								1.5	1.2	1.2	0.8				34.0
36.0								1.2	0.8	0.8					36.0
38.0															38.0
40.0															40.0
42.0															42.0
44.0															44.0
46.0															46.0
48.0															48.0
50.0															50.0
52.0															52.0
54.0															54.0
56.0															56.0
58.0															58.0
	16	12	10	8	7	6	5	5	4	3	3	2	2	2	





Remark: * Need additional device.
备注: * 代表需要借助辅助装置。

Load Chart - Telescopic Boom (T)

性能表 - 主臂



Unit: t

	12.9	17.2	21.5	25.7	30.0	34.2	38.4	42.6	46.9	51.2	55.4	59.6	63.8	68.2	
3.0	100.0	76.0	68.0												3.0
3.5	80.0	75.0	68.0												3.5
4.0	75.0	73.0	67.0	60.0											4.0
4.5	68.5	68.0	67.0	58.0											4.5
5.0	61.5	61.5	60.5	56.0											5.0
5.5	55.5	55.5	54.5	54.0	48.0										5.5
6.0	50.0	50.0	49.5	48.0	45.0										6.0
6.5	45.5	45.5	45.0	44.5	43.0	44.0									6.5
7.0	41.0	41.0	40.5	40.0	40.0	39.0									7.0
7.5	35.1	36.4	36.5	36.0	35.5	35.0	35.0								7.5
8.0	30.3	31.6	32.2	33.7	32.0	31.0	33.7	30.5							8.0
9.0	23.1	24.4	25.1	27.6	27.6	27.2	26.5	26.2							9.0
10.0		19.6	21.6	22.2	22.2	21.8	22.7	20.8	20.9						10.0
12.0		13.4	14.8	15.3	15.3	16.1	15.7	14.5	16.3	15.7	14.9				12.0
14.0			10.7	11.1	12.0	11.8	11.5	11.1	12.0	12.0	10.8	11.2	10.6		14.0
16.0			7.9	8.9	9.1	9.0	8.7	9.6	9.2	9.1	8.7	8.4	7.9	7.9	16.0
18.0				6.9	7.1	7.0	6.7	7.5	7.2	7.1	6.7	6.4	5.9	5.9	18.0
20.0				5.5	5.6	5.5	5.2	6.0	5.6	5.6	5.2	4.9	4.4	4.5	20.0
22.0					4.5	4.4	4.0	4.8	4.5	4.4	4.1	3.8	3.3	3.3	22.0
24.0					3.6	3.4	3.1	3.9	3.5	3.5	3.1	2.8	2.4	2.4	24.0
26.0						2.7	2.3	3.1	2.8	2.7	2.4	2.1	1.6	1.6	26.0
28.0						2.1	1.7	2.5	2.1	2.1	1.7	1.4	1.0	1.0	28.0
30.0							1.2	1.9	1.6	1.6	1.2	0.9			30.0
32.0							0.8	1.5	1.1	1.1					32.0
34.0								1.1	0.8						34.0
36.0								0.8							36.0
38.0															38.0
40.0															40.0
42.0															42.0
44.0															44.0
46.0															46.0
48.0															48.0
50.0															50.0
52.0															52.0
54.0															54.0
56.0															56.0
58.0															58.0
	16	12	10	8	7	6	5	5	4	3	3	2	2	2	

Operating Range - Telescopic Boom + Boom Extension + Fixed Jib (TEJ)

起升高度曲线 - 主臂延伸节 + 副臂

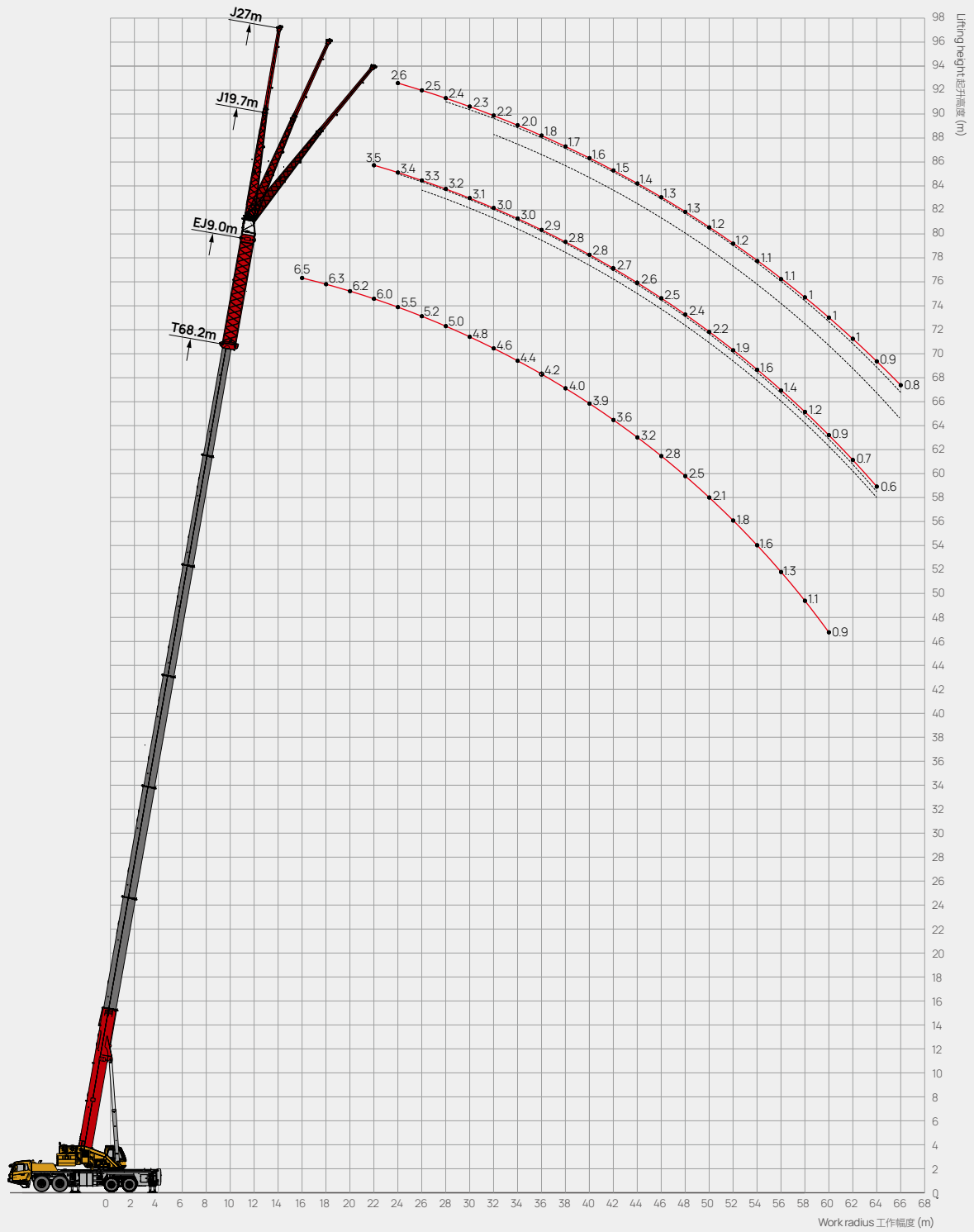

Load Chart - Telescopic Boom + Boom Extension + Fixed Jib (TEJ)

性能表 - 主臂延伸节 + 副臂

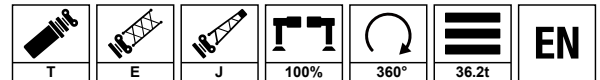

Unit: t

m	68.2m+10.2m			68.2m+17.5m			68.2m+9m	68.2m+9.5m+10.2m			68.2m+9.5m+17.5m			m
	0°	15°	30°	0°	15°	30°	0°	0°	15°	30°	0°	15°	30°	
16.0	5.5						6.5							16.0
18.0	5.5	4					6.3							18.0
20.0	5.3	4	3.3	3.7			6.2							20.0
22.0	5.2	4	3.3	3.6			6	3.5						22.0
24.0	5	4	3.3	3.5	2.4		5.5	3.4	2.8		2.6			24.0
26.0	4.7	3.9	3.2	3.5	2.3		5.2	3.3	2.7	2.2	2.5			26.0
28.0	4.5	3.9	3.2	3.3	2.3	1.6	5	3.2	2.6	2.1	2.4	1.6		28.0
30.0	4.3	3.8	3.2	3.1	2.2	1.6	4.8	3.1	2.6	2	2.3	1.6		30.0
32.0	4.2	3.7	3.1	3	2.2	1.6	4.6	3	2.5	2	2.2	1.5	1.3	32.0
34.0	4	3.6	3	2.8	2.1	1.6	4.4	3	2.4	1.9	2	1.5	1.3	34.0
36.0	3.7	3.5	2.9	2.7	2	1.5	4.2	2.9	2.3	1.9	1.8	1.4	1.2	36.0
38.0	3.4	3.2	2.8	2.6	1.9	1.5	4	2.8	2.2	1.8	1.7	1.3	1.2	38.0
40.0	3.2	3	2.7	2.4	1.8	1.5	3.9	2.8	2	1.8	1.6	1.2	1.2	40.0
42.0	3	2.8	2.6	2.2	1.8	1.4	3.6	2.7	1.9	1.7	1.5	1.2	1.2	42.0
44.0	2.8	2.6	2.4	2	1.8	1.4	3.2	2.6	1.8	1.7	1.4	1.2	1.1	44.0
46.0	2.6	2.4	2.2	1.9	1.7	1.3	2.8	2.5	1.7	1.6	1.3	1.1	1.1	46.0
48.0	2.4	2.2	2.1	1.8	1.6	1.3	2.5	2.4	1.6	1.6	1.3	1.1	1.1	48.0
50.0	2.1	2	2	1.7	1.5	1.3	2.1	2.2	1.5	1.5	1.2	1.1	1.1	50.0
52.0	1.8	1.9	1.9	1.6	1.4	1.3	1.8	1.9	1.4	1.4	1.2	1	1	52.0
54.0	1.6	1.6	1.6	1.5	1.3	1.3	1.6	1.6	1.3	1.3	1.1	1	1	54.0
56.0	1.3	1.3	1.3	1.4	1.3	1.2	1.3	1.4	1.2	1.2	1.1	1	1	56.0
58.0	1.1	1.1	1.1	1.3	1.2	1.1	1.1	1.2	1.1	1.1	1	1	1	58.0
60.0	0.9	0.9	0.9	1.2	1.1	1.1	0.9	0.9	0.9	1	1	1	1	60.0
62.0		0.7	0.7	1.1	1	1		0.7	0.7	0.8	1	0.9	0.9	62.0
64.0					0.9	1		0.6	0.6	0.6	0.9	0.9	0.9	64.0
66.0											0.8	0.8	0.9	66.0
68.0												0.7	0.7	68.0
⚡	1													⚡

Load Chart - Telescopic Boom + Boom Extension + Fixed Jib (TEJ)

性能表 - 主臂延伸节 + 副臂

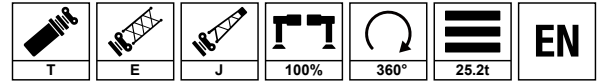

Unit: t



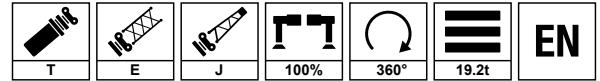

m	68.2m+10.2m			68.2m+17.5m			68.2m+9m	68.2m+9.5m+10.2m			68.2m+9.5m+17.5m			m
	0°	15°	30°	0°	15°	30°	0°	0°	15°	30°	0°	15°	30°	
16.0	5.5						6.5							16.0
18.0	5.5	4					6.3							18.0
20.0	5.3	4	3.3	3.7			6.2							20.0
22.0	5.2	4	3.3	3.6			6	3.5						22.0
24.0	5	4	3.3	3.5	2.4		5.5	3.4	2.8		2.6			24.0
26.0	4.7	3.9	3.2	3.5	2.3		5.2	3.3	2.7	2.2	2.5			26.0
28.0	4.5	3.9	3.2	3.3	2.3	1.6	5	3.2	2.6	2.1	2.4	1.6		28.0
30.0	4.3	3.8	3.2	3.1	2.2	1.6	4.8	3.1	2.6	2	2.3	1.6		30.0
32.0	4.2	3.7	3.1	3	2.2	1.6	4.6	3	2.5	2	2.2	1.5	1.3	32.0
34.0	4	3.6	3	2.8	2.1	1.6	4.4	3	2.4	1.9	2	1.5	1.3	34.0
36.0	3.7	3.5	2.9	2.7	2	1.5	3.9	2.9	2.3	1.9	1.8	1.4	1.2	36.0
38.0	3.4	3.2	2.8	2.6	1.9	1.5	3.4	2.8	2.2	1.8	1.7	1.3	1.2	38.0
40.0	2.9	2.9	2.7	2.4	1.8	1.5	2.9	2.8	2	1.8	1.6	1.2	1.2	40.0
42.0	2.5	2.5	2.5	2.2	1.8	1.4	2.5	2.6	1.9	1.7	1.5	1.2	1.2	42.0
44.0	2.1	2.1	2.1	2	1.8	1.4	2.1	2.2	1.8	1.7	1.4	1.2	1.1	44.0
46.0	1.8	1.8	1.8	1.9	1.7	1.3	1.8	1.9	1.7	1.6	1.3	1.1	1.1	46.0
48.0	1.5	1.5	1.5	1.8	1.6	1.3	1.5	1.6	1.6	1.6	1.3	1.1	1.1	48.0
50.0	1.2	1.2	1.2	1.6	1.5	1.3	1.2	1.3	1.3	1.3	1.2	1.1	1.1	50.0
52.0	0.9	0.9	1	1.4	1.4	1.3	0.9	1	1	1	1.2	1	1	52.0
54.0	0.7	0.7	0.7	1.1	1.2	1.3	0.7	0.8	0.8	0.8	1.1	1	1	54.0
56.0				0.9	1	1.1		0.5	0.6	0.6	0.9	1	1	56.0
58.0				0.7	0.8	0.9					0.7	0.8	0.9	58.0
60.0					0.6	0.7						0.6	0.7	60.0
62.0														62.0
64.0														64.0
66.0														66.0
68.0														68.0
	1													

Load Chart - Telescopic Boom + Boom Extension + Fixed Jib (TEJ)

性能表 - 主臂延伸节 + 副臂



Unit: t

 m	68.2m+10.2m			68.2m+17.5m			68.2m+9m	68.2m+9.5m+10.2m			68.2m+9.5m+17.5m			 m
	0°	15°	30°	0°	15°	30°	0°	0°	15°	30°	0°	15°	30°	
16.0	5.5						6.5							16.0
18.0	5.5	4					6.3							18.0
20.0	5.3	4	3.3	3.7			6.2							20.0
22.0	5.2	4	3.3	3.6			6	3.5						22.0
24.0	5	4	3.3	3.5	2.4		5.5	3.4	2.8		2.6			24.0
26.0	4.7	3.9	3.2	3.5	2.3		5.2	3.3	2.7	2.2	2.5			26.0
28.0	4.5	3.9	3.2	3.3	2.3	1.6	5	3.2	2.6	2.1	2.4	1.6		28.0
30.0	4.3	3.8	3.2	3.1	2.2	1.6	4.7	3.1	2.6	2	2.3	1.6		30.0
32.0	4	3.7	3.1	3	2.2	1.6	4	3	2.5	2	2.2	1.5	1.3	32.0
34.0	3.4	3.4	3	2.8	2.1	1.6	3.4	3	2.4	1.9	2	1.5	1.3	34.0
36.0	2.9	2.9	2.9	2.7	2	1.5	2.8	2.9	2.3	1.9	1.8	1.4	1.2	36.0
38.0	2.4	2.4	2.4	2.6	1.9	1.5	2.4	2.5	2.2	1.8	1.7	1.3	1.2	38.0
40.0	2	2	2	2.4	1.8	1.5	2	2.1	2	1.8	1.6	1.2	1.2	40.0
42.0	1.6	1.6	1.6	2.1	1.8	1.4	1.6	1.7	1.7	1.7	1.5	1.2	1.2	42.0
44.0	1.3	1.3	1.3	1.7	1.8	1.4	1.3	1.4	1.4	1.4	1.4	1.2	1.1	44.0
46.0	1	1	1	1.4	1.6	1.3	1	1.1	1.1	1.1	1.3	1.1	1.1	46.0
48.0	0.7	0.7	0.7	1.2	1.3	1.3	0.7	0.8	0.8	0.8	1.2	1.1	1.1	48.0
50.0				0.9	1	1.1					0.6	0.9	1.1	50.0
52.0				0.7	0.8	0.9					0.7	0.8	0.9	52.0
54.0					0.6	0.7						0.6	0.7	54.0
56.0														56.0
58.0														58.0
60.0														60.0
62.0														62.0
64.0														64.0
66.0														66.0
68.0														68.0
 	1													

Load Chart - Telescopic Boom + Boom Extension + Fixed Jib (TEJ)

性能表 - 主臂延伸节 + 副臂

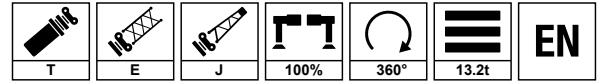

Unit: t

m	68.2m+10.2m			68.2m+17.5m			68.2m+9m	68.2m+9.5m+10.2m			68.2m+9.5m+17.5m			m
	0°	15°	30°	0°	15°	30°	0°	0°	15°	30°	0°	15°	30°	
16.0	5.5						6.5							16.0
18.0	5.5	4					6.3							18.0
20.0	5.3	4	3.3	3.7			6.2							20.0
22.0	5.2	4	3.3	3.6			6	3.5						22.0
24.0	5	4	3.3	3.5	2.4		5.5	3.4	2.8		2.6			24.0
26.0	4.7	3.9	3.2	3.5	2.3		4.9	3.3	2.7	2.2	2.5			26.0
28.0	4.1	3.9	3.2	3.3	2.3	1.6	4.1	3.2	2.6	2.1	2.4	1.6		28.0
30.0	3.4	3.4	3.2	3.1	2.2	1.6	3.4	3.1	2.6	2	2.3	1.6		30.0
32.0	2.8	2.8	2.8	3	2.2	1.6	2.8	2.9	2.5	2	2.2	1.5	1.3	32.0
34.0	2.3	2.3	2.3	2.7	2.1	1.6	2.2	2.4	2.4	1.9	2	1.5	1.3	34.0
36.0	1.8	1.8	1.8	2.3	2	1.5	1.8	1.9	1.9	1.9	1.8	1.4	1.2	36.0
38.0	1.4	1.4	1.4	1.9	1.9	1.5	1.4	1.5	1.5	1.5	1.7	1.3	1.2	38.0
40.0	1	1.1	1.1	1.5	1.7	1.5	1	1.1	1.2	1.2	1.6	1.2	1.2	40.0
42.0	0.7	0.7	0.7	1.2	1.3	1.4	0.7	0.8	0.8	0.8	1.2	1.2	1.2	42.0
44.0				0.9	1	1.2					0.9	1.1	1.1	44.0
46.0				0.6	0.8	0.9					0.7	0.8	1	46.0
48.0						0.6						0.6	0.7	48.0
	1													

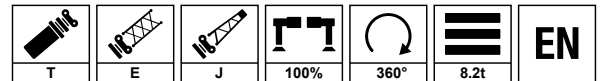

Unit: t



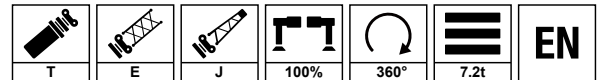

m	68.2m+10.2m			68.2m+17.5m			68.2m+9m	68.2m+9.5m+10.2m			68.2m+9.5m+17.5m			m
	0°	15°	30°	0°	15°	30°	0°	0°	15°	30°	0°	15°	30°	
16.0	5.5						6.5							16.0
18.0	5.5	4					6.3							18.0
20.0	5.3	4	3.3	3.7			6.2							20.0
22.0	5.2	4	3.3	3.6			5.5	3.5						22.0
24.0	4.5	4	3.3	3.5	2.4		4.5	3.4	2.8		2.6			24.0
26.0	3.6	3.7	3.2	3.5	2.3		3.6	3.3	2.7	2.2	2.5			26.0
28.0	2.9	2.9	3	3.3	2.3	1.6	2.9	3.1	2.6	2.1	2.4	1.6		28.0
30.0	2.3	2.3	2.4	2.8	2.2	1.6	2.3	2.4	2.5	2	2.3	1.6		30.0
32.0	1.8	1.8	1.8	2.3	2.2	1.6	1.8	1.9	1.9	1.9	2.2	1.5	1.3	32.0
34.0	1.3	1.3	1.4	1.8	2	1.6	1.3	1.4	1.5	1.5	1.9	1.5	1.3	34.0
36.0	0.9	0.9	1	1.4	1.6	1.5	0.9	1	1	1.1	1.5	1.4	1.2	36.0
38.0	0.6	0.6	0.6	1	1.2	1.4		0.7	0.7	0.7	1.1	1.3	1.2	38.0
40.0				0.7	0.9	1.1					0.8	1	1.1	40.0
42.0					0.6	0.7						0.7	0.8	42.0
44.0														44.0
46.0														46.0
48.0														48.0
	1													

Load Chart - Telescopic Boom + Boom Extension + Fixed Jib (TEJ)

性能表 - 主臂延伸节 + 副臂





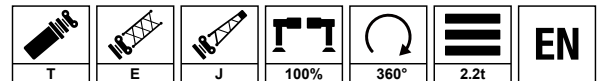

Unit: t

	68.2m+10.2m			68.2m+17.5m			68.2m+9m	68.2m+9.5m+10.2m			68.2m+9.5m+17.5m			
	0°	15°	30°	0°	15°	30°	0°	0°	15°	30°	0°	15°	30°	
16.0	5.5						6.5							16.0
18.0	5.5	4					6.3							18.0
20.0	5.3	4	3.3	3.7			6.2							20.0
22.0	5.2	4	3.3	3.6			5.2	3.5						22.0
24.0	4.2	4	3.3	3.5	2.4		4.2	3.4	2.8		2.6			24.0
26.0	3.4	3.4	3.2	3.5	2.3		3.4	3.3	2.7	2.2	2.5			26.0
28.0	2.7	2.7	2.7	3.2	2.3	1.6	2.7	2.8	2.6	2.1	2.4	1.6		28.0
30.0	2.1	2.1	2.1	2.6	2.2	1.6	2.1	2.2	2.2	2	2.3	1.6		30.0
32.0	1.6	1.6	1.6	2	2.2	1.6	1.5	1.7	1.7	1.7	2.1	1.5	1.3	32.0
34.0	1.1	1.2	1.2	1.6	1.8	1.6	1.1	1.2	1.3	1.3	1.7	1.5	1.3	34.0
36.0	0.7	0.8	0.8	1.2	1.4	1.5	0.7	0.9	0.9	0.9	1.3	1.4	1.2	36.0
38.0				0.9	1.1	1.2					0.9	1.1	1.2	38.0
40.0				0.6	0.7	0.9					0.6	0.8	1	40.0
42.0						0.6							0.7	42.0
	1													



Unit: t

	68.2m+10.2m			68.2m+17.5m			68.2m+9m	68.2m+9.5m+10.2m			68.2m+9.5m+17.5m			
	0°	15°	30°	0°	15°	30°	0°	0°	15°	30°	0°	15°	30°	
16.0	5.5						6.5							16.0
18.0	5.5	4					6.2							18.0
20.0	4.8	4	3.3	3.7			4.8							20.0
22.0	3.7	3.7	3.3	3.6			3.7	3.5						22.0
24.0	2.8	2.9	2.9	3.3	2.4		2.8	3	2.8		2.6			24.0
26.0	2.1	2.1	2.2	2.6	2.3		2.1	2.3	2.3	2.2	2.5			26.0
28.0	1.5	1.5	1.6	2	2.3	1.6	1.5	1.6	1.7	1.7	2.1	1.6		28.0
30.0	1	1	1.1	1.5	1.8	1.6	1	1.1	1.2	1.2	1.6	1.6		30.0
32.0	0.6	0.6	0.6	1	1.3	1.5		0.7	0.7	0.7	1.1	1.4	1.3	32.0
34.0				0.7	0.9	1.1					0.7	1	1.2	34.0
36.0						0.7						0.6	0.8	36.0
38.0														38.0
40.0														40.0
42.0														42.0
	1													



SANY GROUP CRANE BU

SANY Mobile Crane Industrial Park, No.168 Jinzhou Avenue, Jinzhou Development Zone, Changsha City,
Hunan Province, P.R. China Zip 410600
Consulting sanycrane@sanygroup.com (Crane BU) / crd@sany.com.cn (IHQ)
After-sales Service 0086-400 6098 318

Reminder:

Any change in the technical parameters and configuration due to product modification or upgrade may occur without prior notice.
The machine in the picture may include additional equipment. This brochure is for reference only, and goods in kind shall prevail.
Copyright at SANY. No part of this brochure may be copied or used for any purpose without written approval from SANY.

© Edited in October 2023

三一集团起重事业部

中国湖南长沙金洲开发区金洲大道 168 号 三一汽车起重机产业园 邮编: 410600
咨询: sanycrane@sanygroup.com (起重事业部) / crd@sany.com.cn (国际总部)
海外售后服务: 0086-400 6098 318

温馨提示:

由于技术不断更新, 技术参数及配置如有更改, 恕不另行通知。图中机器可能包括附加设备, 本画册仅供参考, 以实物为准。
版权为三一所有, 未经三一书面许可, 本画册任何内容不得被复制用于任何目的。

© 2023 年 10 月版

